



AG-1200+

AG-1200+

Float Switch System for Metal and Plastic Secondary Pans

The AG-1200+ has all of the features of the 1100+ plus an innovative two-piece clamp design which allows it to be mounted to a metal drain pan (without a lip) or inferior, non-AquaGuard plastic drain pan (with a lip) in 10 seconds or less, without the need for a drain hole in the pan.

Key Features

- 5 amp high-capacity sensor designed for metal and plastic pans
- The industry leading float switch for metal and plastic drain pans
- Easy, no-drill installation
- Protective housing keeps out insulation and debris
- NEW Open circuit wiring option



Product Specs

- UL LISTED (UL 508)
- NORMALLY CLOSED OR NORMALLY OPEN
- VERTICAL TRIGGER DEPTH OF 3/4 INCH
- VOLTAGE RATING: 24VAC, 5.0A

Magnetic Trigger System

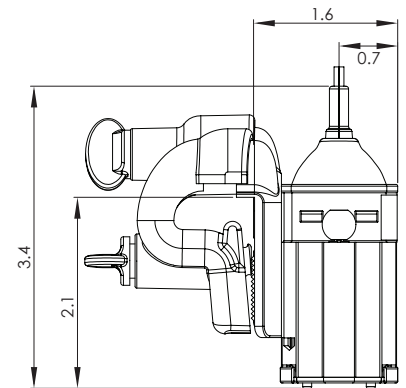
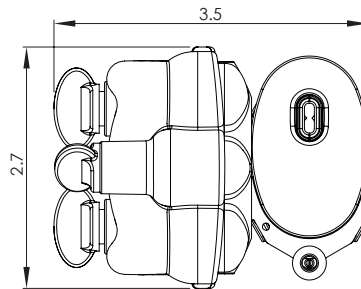
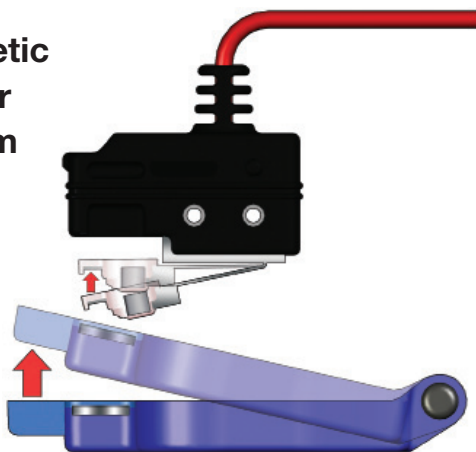





www.rctus.com • 888-708-6622

6408 Parkland Drive • Suite 102 • Sarasota, FL 34243

RESOURCE
CONSERVATION TECHNOLOGIES

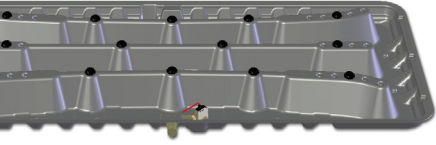
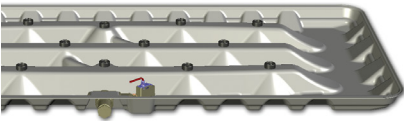
DRAIN PAN SELECTION CHART

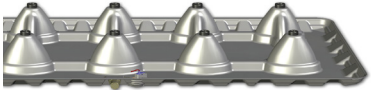

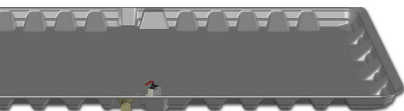
Secondary Pan Model	Pan Size	External Pan Size			Max Unit Size		Recommended Application
Goliath Series		Width	Length	Height	Width	Length	
	30x50	28.38"	50.50"	5.25"	25.38"	54.25"	Hangable When additional clearance is needed under air handler for drain. General Purpose for both furnace and air handler installation.
	30x62	28.25"	69.13"	4.25"	26.0"	66.50"	
	28x57	30.25"	57.25"	4.0"	27.25"	47.50"	
	28x69	30.38"	63.0"	4.25"	27.38"	60.0"	
Goliath Low Profile		Width	Length	Height	Width	Length	
	26x56	56.63"	26.50"	2.75"	23.50"	53.63"	Hangable When space is at a minimum in a garage or attic.
Goliath Furnace Series		Width	Length	Height	Width	Length	
	30x36	30.50"	37.50"	3.0"	27.50"	34.50"	Non-Hangable For Vertical, upflow installation of furnace or air handler.
Goliath Furnace Series		Width	Length	Height	Width	Length	
	34x64	34.13"	64.13"	7.50"	31.13"	61.13"	Non-Hangable When greater clearance height is needed to accommodate piping under furnace.
	34x79	33.75"	79.0"	7.50"	30.75"	76.0"	
Spartan Non-Hangable		Width	Length	Height	Width	Length	
	30x50	30.25"	50.50"	4.0"	27.25"	47.5"	Non-Hangable General purpose for air handler installation.
	30x62	30.38"	63.0"	4.25"	27.38"	60.0"	
Titan Flexible Series		Width	Length	Height	Width	Length	
	24x24	24.0"	24.0"	2.25"	20.0"	20.5"	Non-Hangable Flexible and durable enough to bend and fit into tight spaces.
	26x26	26.0"	26.0"	2.25"	22.0"	22.5"	
	30x30	30.0"	30.0"	2.25"	26.0"	26.5"	
	32x32	32.0"	32.0"	2.25"	28.0"	28.5"	
Titan Flexible Series		Width	Length	Height	Width	Length	
	30x50	30.25"	50.5"	2.50"	27.25"	47.50"	Hangable Flexible and durable enough to bend and fit into tight spaces.
	30x62	30.38"	63.0"	2.50"	27.38"	60.0"	