



Making Your Job More Enjoyable

Smart Refrigerant Charging Machine

NRC62i

User Manual



Failure to follow warnings could result in death or serious injury.

**SAVE THIS MANUAL
FOR FUTURE REFERENCE**

NAVAC Inc.

T +1 201.939.6699

F +1 201.939.3899

www.NavacGlobal.com

CONTENTS

TECHNICAL SPECIFICATIONS	01
SAFETY PRECAUTIONS	01
WORKING PRINCIPLES AND APPLICATION	02
CONNECTING TO THE EQUIPMENT	03
MACHINE PARTS AND FUNCTIONS	03
INSPECTIONS BEFORE OPERATION	06
OPERATION PROCEDURES	06
ROUTINE USE AND MAINTENANCE	08
SPECIAL MAINTENANCE OPERATION	10
TROUBLESHOOTING	12

TECHNICAL SPECIFICATIONS

Compatible Refrigerants	Type III: R-12, R-134a, R-401C, R-406A, R-500
	Type IV: R-22, R-401A, R-401B, R-402B, R-407C, R-407D, R-408A, R-409A, R-411A, R-411B, R-412A, R-502, R-509
	Type V: R-402A, R-404A, R-407A, R-407B, R-410A, R-507
Power Supply	110V / 60Hz
Evacuation Rate	6 CFM
Charging Rate	4 lbs/min
Motor Power	1/2 HP
Operating Temperature	41-104 °F
Dimension	19.7" × 10" × 14.5"
Weight	46.9 lbs

SAFETY PRECAUTIONS

Safety instructions

1. This evacuation and charging machine designed for use only by trained HVACR professionals, and can be damaged or dangerous if operated incorrectly.
2. For your safety and correct operation, please read the operation manual carefully before use.
3. Never connect vacuum pump to a pressurized system, and always verify system is at atmospheric pressure or below before connecting hoses to an HVACR system.
4. Protective gloves and goggles should be worn during operation in case refrigerant gas or liquid comes in contact with skin or eyes.
5. Do not smoke while operating evacuation or charging equipment.
6. Do not use machine near flammable gases, open flames, or other ignition source.
7. Please do not use equipment in direct sun or in rain, cover if needed, leaving adequate room for ventilation.
8. Always make sure the equipment has good ventilation.

Precautions:

1. The smart refrigerant charging machine is for use with air conditioning and refrigeration systems only.
2. The red high-pressure hose is connected to the high pressure (liquid) valve on A/C-R systems and blue low pressure hose to the low-pressure (suction) valve.
3. Before operation, verify the type of refrigerant used to insure compatibility.
4. Charge cooling systems with the correct type of refrigerant and correct weight recommended by the manufacturer and calculated for associated piping.
5. Verify that power supply is 110V to the charging machine before powering on. Make sure the power supply is grounded.
6. Make sure all valves in the refrigerant charging machine are in the OFF position before connecting hoses to the system to be evacuated and charged.

7. Keep process hoses away from all moving parts, and any excessive heat in the system.
8. Check the oil level and condition in vacuum pump section of the charging machine before operation, change oil if needed.
9. Please do not alter the position of switch valve on refrigerant storage tank.
10. Only certified refrigerant tanks can be used.
11. Do not use vacuum pump oil in air conditioning systems, or refrigeration oil in vacuum pumps.
12. Keep high/low-pressure stop valves in the OFF position when the machine is not used. Protective caps should be kept on the high-pressure, low-pressure, and refrigerant inlet port connectors to prevent moisture, dirt, and air from entering the charging equipment that may adversely affect performance and service life.
13. Power extension cords should be no more than 75 feet long to prevent voltage drop.
14. Always follow safety precautions while moving and handling refrigerant storage tanks. Although refrigerant is non-toxic, odorless, non-corrosive and non-flammable, technicians must avoid inhalation of high-concentrations of vapor which displaces air, causing oxygen deprivation. Avoid skin contact with liquid refrigerant which may cause frostbite. Avoid phosgene gas, an acidic vapor formed by decomposition of refrigerant burned by open flame.

Note:

1. There may be a small amount of oil mist spraying from the oil fill port at the beginning of equipment evacuation. This is normal. The oil mist will become less with time, until it disappears.
2. In the process of evacuation, the vacuum display will be temporarily disabled, if it comes in contact with trace amounts of refrigerant, and it will automatically return to normal display after the refrigerant has been evacuated.

Precautions at operation and use of refrigerant

Under the normal circumstances, refrigerant is a pressurized liquid. For ease of use and transportation, it is stored in a certified cylinder. Special attention should be paid during use. The technician should avoid inhalation of highly concentrated gaseous refrigerant, even in a very short time, because inhalation the vapor may cause loss of consciousness or death. Wear the protective gloves and goggles during use to prevent liquid from contacting skin and eyes in case of release.

WORKING PRINCIPLES AND APPLICATION

1. NRC62i Smart Refrigerant Charging Machine is a precision multi-function piece of equipment, used to evacuate and precisely charge air-conditioning and refrigeration systems. It consists of a vacuum pump, a leak detection system, and programmable charging machine with scale. After simple programming, the machine first evacuates and leak tests the system to be charged, and then charges the pre-programmed amount of refrigerant, and finally pressure tests the system.
2. The entire process offers convenience, safety, energy savings, accuracy, and environmental protection. The charging machine is used while installing or servicing a wide variety of air conditioning and refrigeration equipment, from ductless split units to commercial package and split systems.
3. The automated charging machine has a memory function so that should a power failure occur, the isolation valves close, the program is saved, and you can resume operation by restarting the system by simply pressing the start button.

CONNECTING TO THE EQUIPMENT

Install the high-pressure (red) and low-pressure (blue) hoses as shown to connect to air conditioning or refrigeration system. The red hose is connected to the "HP (high pressure)" connection on the charging machine, and the blue to the "LP (low pressure)" connection. The inlet port of refrigerant is connected to the refrigerant cylinder. Purging the hose while making the connection to the charging machine. Be sure to position the cylinder in the proper orientation for charging, per the instructions from the manufacturer. Also note that a refrigeration manifold is NOT used for this operation, as internal solenoid valves isolate the system once all functions are concluded.

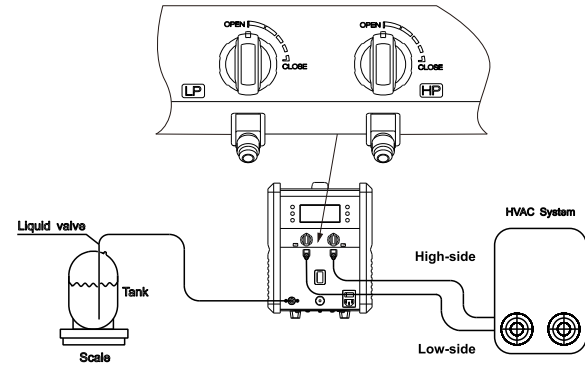

MACHINE PARTS AND FUNCTIONS

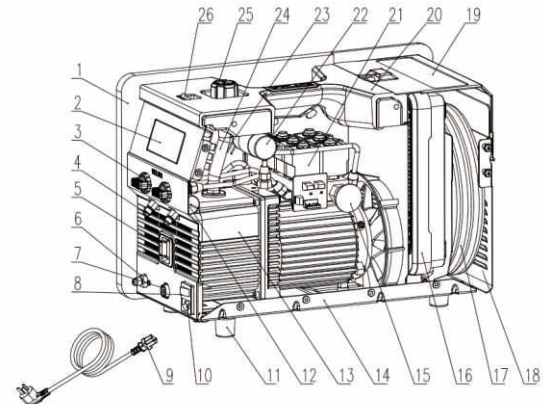

1. Housing
2. Control Panel
3. High/Low-Pressure Stop Valve
4. High/Low-Pressure Hose Connector
5. Oil Level Window
6. Refrigerant Inlet Port
7. Vacuum Pump Oil Drain
8. Power Switch
9. Power Cable
10. Power Socket
11. Rubber Feet
12. Pressure Sensor
13. Vacuum Pump
14. Baseplate
15. Vacuum Sensor
16. Wireless Electronic Scale
17. Refrigerant Hoses
18. Back Panel
19. Rotation Cover
20. Handle
21. Solenoid Valve Assembly
22. Start Capacitor
23. Electronic Starter
24. Oil Filling Conduit
25. Filler Cap
26. Strap Bending Pin

Display on control panel

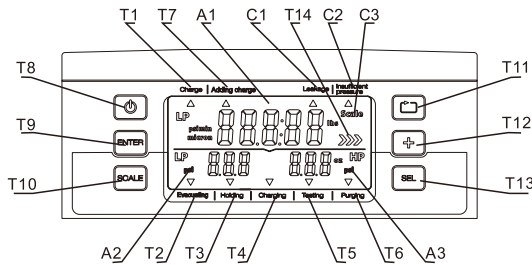

Digital display area

- A1: Main display area
- A2: Pressure display area at low-pressure side
- A3: Pressure display area at high-pressure side

State and alarm

C1. Leakage warning

During evacuation, the alarm will sound if the vacuum value cannot be reached within the specified time. The operation will automatically stop and light will flash, indicating that a leak needs to be fixed before resuming evacuation. During the vacuum hold leak detection cycle, if changes in vacuum value exceed the specified value, the buzzer sounds and the vacuum test ends and the light flashes. Press to disable the alarm buzz. After completion of leak repairs, press the button again to re-start the evacuation process.

C2. Insufficient pressure warning

During the charging process, if the volume cannot meet the system setting requirement in 30 seconds, the alarm buzzes; the charging suspends automatically and the light flashes. Press to disable the alarm. After replacement of the refrigerant cylinder, press the again to resume the charging process and add the remaining volume.

C3. Electronic scale indicator light

The alarm sounds when the reading of electronic scale is more than 220 lbs. If the wireless electronic scale is not in sync, the light flashes continuously. When it is connected, the light remains on.

Function button and indication

- T1. Charge indicator
When the light is on, three successive programs of evacuation, holding, and charging will be performed.
- T2. Evacuating indicator
The light flashes during the evacuation phase.
- T3. Holding indicator
The light flashes during leak testing.
- T4. Charging indicator
The light flashes during the refrigerant charging process.
- T5. Testing indicator
The light flashes during the working pressure test.
- T6. Purge indicator
The light flashes when the machine purges the refrigerant in the unit.
- T7. Adding charge indicator
When the light flashes, three programs of evacuation of the charging machine, holding a vacuum in the charging machine, and adding charge, will be performed.
- T8. Start/Stop button
When the operator presses the button, the indicator light is on and the corresponding operation is performed. Once again, the indicator light flashes, and the corresponding operation stops.
- T9. ENTER button
When an indicator light of an operation is on, but does not flash. After changes are complete, press the button again to confirm the figures.
- T10. SCALE display interface button
When the operator presses the button, the operation interface of electronic scale displays and the "electronic scale" indicator light is on.
- T11. Cycle button
When the operator sets pressure and weight, there is a figure flashing on the digital display. After you press the button, the next figure flashes. Then, the flashing figure can be modified.
- T12. "+" button
When the operator determines pressure and weight, the displayed digital figure will increase one unit each time you press the button.
- T13. "SEL" button
Select the operation to be performed. When each time the operator presses the button, T1 to T7 light will be on successively. The light beside each operation indicates that the operation can be started or is ongoing (light flashes). Press the SEL button for 2 seconds to return the previous interface.
- T14. Running indicator
When a program is running, the three arrows are lit one by one. All three are lit when the program is completed.

INSPECTIONS BEFORE OPERATION







1. Open the carton
Open it after checking the external carton. Please read the user manual carefully at least one time and keep the documents and accessories in their proper place.
2. Check work area for unsafe conditions, such as open heat source or fire source in the area.
3. Check oil level and condition in vacuum pump, making sure the oil level is in the middle; otherwise, change oil as described in the routine maintenance section.
4. Check valves
Verify the high/low-pressure valves and fill valve are closed, and all system switches are OFF.
5. Open the back cover at the rear of the charging machine and take out the wireless electronic scale. Put it onto flat dry ground and turn on the scale.
6. Verify that refrigerant used in the system is the same as that in the refrigerant cylinder.
7. Take out hoses and power cable from the case at the rear of the charging machine.
8. Verify 110V power source, then turn on power supply switch.
9. Connection
Connect one end of the blue hose to "LP (low pressure)" connection on the charging machine and the other end with the suction line on the equipment. Connect one end of the red hose with "HP (high pressure)" connection on the charging machine and the other end with the liquid line connection on the equipment. Connect one end of another refrigeration hose (yellow) to the valve on the refrigerant cylinder and the other end to the refrigerant fill port of the equipment.

Note:

The system can be evacuated by a single hose connection. In this case, either red or blue hose connection will work.

OPERATION PROCEDURES

Evacuation

1. When there is no refrigerant in the system to be charged, the charging machine will automatically enter "Charging" status. The indicator light under the Charging will be on.
2. Make sure both high and low-pressure valves are turned on. For single hose connection, only open the valve connected with the evacuation hose.
3. Press  and the screen will display the charge weight from the last use. If charge weight is identical to the last charged system, press  to start evacuation.
4. If new charging weight is to be set, the first digit on the left side of the display flashes. Press  to move digit up and down to desired setting. Press  to move position and  to change values in this digit. Continue until desired charge figure is set. Then press  to set the program. Press  again to start the system evacuation program. Evacuating indicator light flashes until evacuation program is complete and then remains on. Other function lights are off. The three arrows of running indicator lights on the screen are lit one by one during the process until the program ends and then all stay on when finished.
5. When the vacuum level reaches 3,750 microns, the computerized charging system will calculate remaining system evacuation time based on time to reach the 3,750 microns along with the charging weight, and continue the evacuation process, displaying remaining charging time or microns, depending on chosen display settings.

6. If within 50 minutes (system default time), vacuum doesn't reach the preset 3,750 microns, the system will sound an alarm buzz indicating the system has a leak, evacuation stops, and the leak indicator light on the screen flashes and running light turns off.

Holding

1. After completion of evacuation program, the charging machine goes into "System Vacuum Hold" program to check for system leaks.
2. The three arrows of running indicator light continue to be lit one by one. Charging and Evacuation lights stay on. "Holding" light flashes till the program ends and then remains on when the test is complete, indicating the system is ready to be charged.
3. Wait 2 minutes for the system to confirm that the vacuum level isn't rising, or its variation value is less than the setting and has stopped rising during this time. It passes the leak test. If the vacuum continues to rise, it indicates that there is a leak in air conditioning or refrigerations system. The charging machine will buzz an alarm; operation suspends, leak indicator light on the screen flashes.
4. The screen counts down from 2 minutes. After countdown with no rise in vacuum level, the system then advances to the "Charging" program.

Refrigerant charging

1. After the vacuum hold test is complete, the charging machine will automatically run the Charging program. Charging, Evacuating and Holding lights stay on. The Charging light flashes till the program ends and then stays on. The system automatically enters Charging refrigerant mode and the three arrows of run indicator lights flash one by one until the program is finished and then remain on.
2. The screen displays countdown of remaining charging weight until it reads 0. Operation stops.
3. Since there is residual refrigerant in the hoses, the system will automatically charge 2.5 oz more to compensate for these "de minimus" losses.
4. If within 30 seconds, the charged weight is less than or equal to 0.7 oz, the alarm buzzes. The insufficient pressure indicator light flashes and running indicator light turns off. After replacing refrigerant cylinder, press  to continue adding the remaining refrigerant by weight into the system.
5. After charging is complete, the buzzer sounds and the charging machine advances to pressure test program.

Note: If the high/low pressure value is 0, it can not go to charging process.

Pressure test

After charging is completed, the charging machine enters working pressure test program (operator can also press  to skip this step and advance to purging program). Now all solenoid valves are closed. The charging machine is now at standby mode.

Purging

1. Press to enter Purging program and purging light turns on. Press to start the process, and the purging indicator light flashes.
2. While performing Purging program, the purging indicator light flashes and other lights are off. It displays a 10 seconds countdown for purge run time. The three arrows of running indicator light on the screen alternately flash, then stay on when the screen displays countdown has reached zero (0).
3. Wait a few seconds and remove high and low pressure hoses. Turn off the charging machine.
4. Verify valve of refrigerant cylinder is closed and remove the hose.

Note:

If there is residual refrigerant in the refrigeration or air conditioning system to be charged, the machine will enter automatically the Adding charge program. System screen requires the technician to input the pressure value on low-pressure side. Input the value according to the recommendation from refrigeration system manufacturer. Press to run the program. Procedures are the same as that for complete charging.

ROUTINE USE AND MAINTENANCE

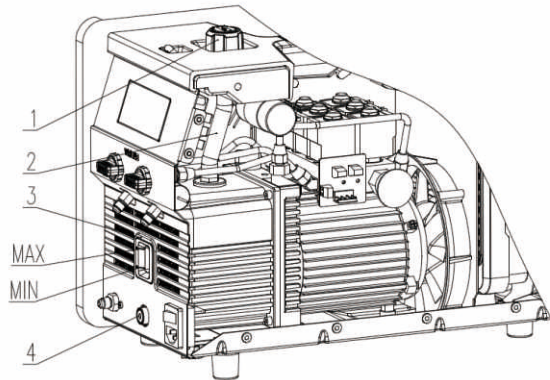

Vacuum pump

1. Vacuum pump oil has three major functions: pump lubricant, pump cooling, and pump sealant. During the evacuation process, the pump oil will absorb moisture being evacuated from the system, causing it to be less effective as a lubricant and pump vane seal, extending evacuation time and possibly causing the pump to overheat.
2. Only special purpose vacuum pump oil is to be used as required.

Note:

In order to properly check the oil level in the vacuum pump, run the vacuum pump for one minute and check oil level in the vacuum pump sight glass.

Adding Vacuum Pump Oil

When the oil level is lower than the MIN position in oil level window, vacuum pump oil must be added. Use the following procedure:

1. Disconnect the power plug to the charging machine.
2. Remove the oil fill cap and add vacuum pump oil to the inlet under the fill cap. Add oil a little at a time until the oil level reaches the middle position between MAX and MIN marks on the oil level window. Place back the oil fill cap and tighten.

Note:

When the pump runs, oil level must be between the upper and lower lines of MAX and MIN. Too low oil level will degrade performance of the pump, while too high oil level will cause a large quantity of oil mist to discharge from the oil fill port.

Replace vacuum pump oil

We recommend that the oil be changed just before evacuating each A/C-R system to insure the pump oil is in a clean condition as this is the key factor in determining if the pump can achieve the required vacuum levels. In order to maintain the optimum operation of the pump, we recommend that you use NAVAC vacuum pump oil. This oil is made using a unique process and can maintain proper viscosity during normal operation and temperatures, and it's also helpful for cold startup. Should the NAVAC oil not be available, reputable brands of special purpose vacuum pump oil may be used.

Note:

Should the pump oil become opaque, dirty, or full of moisture, promptly change oil.

1. Run vacuum pump for 1 minute to warm oil.
2. Disconnect power supply to the charging machine.
3. Remove oil fill cap and loosen the oil drain valve. Slant the pump body and remove the oil drain valve, draining used oil into an appropriate container and dispose of properly.
4. After draining oil, tighten the oil drain valve. Fill with new vacuum pump oil until the oil level reaches the line just below MAX. Tighten the oil filler cap. Run briefly (less than one minute) to verify proper oil level (between MIN and MAX) before use.

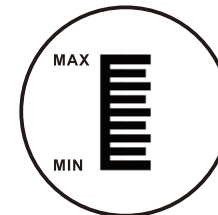

SPECIAL MAINTENANCE OPERATION

Wireless refrigerant scale operation procedures



1. Connect power to the Charging Machine and turn on the power switch.
2. Open the rotating cover on the back of the machine and take out the wireless refrigerant scale and remove scale keypad; put it on a flat, dry, and stable surface.
3. Press the scale power switch for 1 second to turn on the wireless refrigerant scale, and press the power button of the scale keypad to turn it on.
4. The Charging Machine automatically connects with the wireless refrigerant scale wirelessly through a bluetooth connection. On the screen, the wireless refrigerant scale indicator light flashes first, the alarm sounds and then the light stays solid, and then turns off. The scale indicator light stays on, indicating it is connected to the charging machine.
5. On the screen, press wireless refrigerant scale display button and the system advances to a separate scale screen. In the "Current digital display" area on the screen, it displays the current weight on the wireless scale.
6. At the scale program, is for zero clearance. is for returning to the previous step. Pres button for 2 seconds to exit scale screen and return to the previous screen.

Note: for more scale operations, please refer the scale manual.

Wireless refrigerant scale buttons



No.	Button	Function Description
1		Weight scale ON/OFF power button
2		Wireless sync bluetooth button

Process for synchronizing wireless communication

If synchronization is unsuccessful or new sync is required after the handheld terminal is replaced, wireless sync communication will clear the previous bluetooth connection to scale, and then sync the new component. Detailed operations are as follows:

1. Make sure the scale is not weight loaded. Turn on the charging machine and scale. If the indicator flashes, the blue indicator of scale flashes, then it means the sync does not succeed.
2. Press the button of charging machine to enter scale program.
3. Press simultaneously for 3 seconds to enter re-sync program. It shows **---** on the screen and buzzes. Within 1 minute, it shows **hffl**, and the re-sync is done. The charge machine will automatically save the MAC address for the new scale, it buzzes for 5 seconds before completing the process. If the re-sync does not succeed within 1 minute, it will exit the process while still keeping the MAC address of previous scale. In this case, repeat the process from the beginning. When the blue light of the scale and the scale indicator light on the charging machine stay on, it indicates that the sync is successfully completed.

Other settings

Change units of weight.

Turn on the power switch. Press simultaneously Start/stop button and SEL button. The system will switch between the two weight units.

TROUBLESHOOTING

PROBLEM	CAUSE	REMEDY
Difficult start-up	1. Motor or power supply fails	Check and repair
	2. Power voltage is too low	Check power voltage
	3. Extension power cable is too long	Shorten the length of power cord to eliminate voltage drop
	4. Foreign substance falls into the vacuum pump	Check and clear it
Oil leaking	1. Vacuum pump oil seal is damaged	Replace the oil seal
	2. Oil tank connecting tube is loose or damaged	Tighten the screw or replace the O ring
Oil discharge from fill/exhaust cap	1. Too much oil in pump	Drain oil to the oil level line
Leak alarm in vacuum mode	1. Insufficient oil in the vacuum pump	Fill oil to the centerline of oil mark
	2. Engine oil in the vacuum pump is emulsified, or dirty	Replace with new oil
	3. Oil inlet port of vacuum pump is blocked or oil supply to the pump is insufficient	Clean oil inlet port and filter screen
	4. The copper connection hose leaks	Check the connection hose
	5. Components on the pump worn out due to long hours of use	Check and repair the pump or replace it with a new one
	6. Manifold connection is loose	Tighten the connector
Electronic scale alarm	1. The wireless electronic scale is too far from the Charging System	Have the electronic scale close to the charging system
	2. The weight of the refrigerant cylinder is beyond the range of the electronic scale	Select a proper refrigerant cylinder
	3. Something is wrong with wireless sync	Re-sync the scale to the charging system following instructions
	4. There is no refrigerant cylinder on the scale while charging	Put the refrigerant cylinder on the scale
Alarm because of insufficient pressure	1. Not enough refrigerant left in cylinder, or cylinder has been in very cold ambient conditions	Replace the refrigerant cylinder, or warm if very cold
